



SOCIALIZING



CLIMBING



SLIDING



#### INFORMATION ABOUT THE PRODUCT







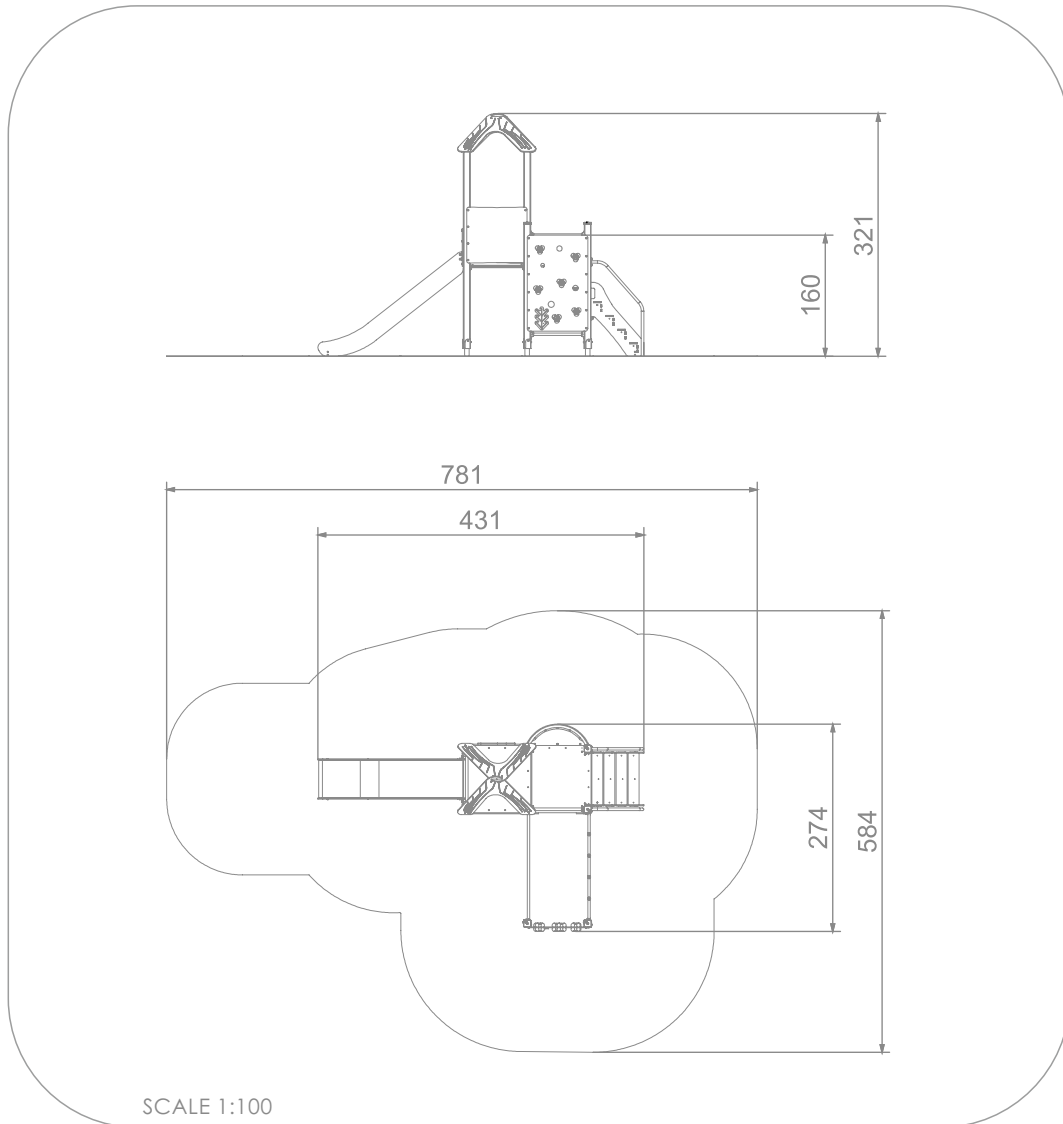

Dimensions	274 x 431 cm
Safety zone	584 x 781 cm
Safety zone area	32 m <sup>2</sup>
Overall height	321 cm
Free fall height	160 cm
Amount of users	12
Product complies with EN 1176-1:2017	YES
Availability of spare parts	YES
Age range	3-12
<small>According to EN 1176-1:2017 norm, the product requires applying a safety surface according to the product's free fall height.</small>	



## 8025



### MATERIALS:

<p>SOFT CONIFER WOOD CORELESS, GLUED IN LAYERS WITH POLYURETHANE GLUES, TOTALLY RESISTANT TO WATER.</p> 	<p>WOODEN POSTS ANCHORED TO THE GROUND WITH POWDER GALVANIZED AND POWDER COATED STEEL ANCHORS.</p> 	<p>PATENTED SYSTEM OF CONNECTORS AND CLAMPS MADE OF STRONG ALUMINIUM ALLOY.</p> 	<p>PLATES OF THE WALLS MADE OF COLOURFUL TRIPLE LAYERED 15 MM HDPE POLYETHYLENE, IN THE HIGHEST QUALITY, TOTALLY DAMP-PROOF.</p> 	<p>ROPE ENDINGS PRESSED IN A SLEEVE MADE OF DURABLE ALUMINIUM ALLOY.</p> 	
<p>ANTI-SLIP ANTHRACITE 10MM HPL PLATFORM PLATE WITH A VERY HIGH RESISTANCE TO WEATHER CONDITIONS AND ATTRITION.</p> 	<p>SLIDES MADE OF STAINLESS STEEL AISI 304. METAL SHEET WITH A THICKNESS OF 2 MM FORMED IN A CNC TECHNIQUE.</p> 	<p>SYSTEM OF CONNECTORS AND CLAMPS MADE OF STRONG ALUMINIUM ALLOY.</p> 	<p>SOLID AND ESTHETIC ROPE CONNECTORS MADE OF INJECTION MOLDED POLYAMIDE.</p> 	<p>POLIPROPYLENE ROPES PPMULTISPLIT TYPE WITH A STEEL CORE AND A DIMETER OF 16 MM.</p> 	<p>CLIMBING ROCKS MADE OF CHIPPINGS AND COLOURFUL POLYESTER RESIN.</p> 